

1 2 3 4 5 6

A

B

C

D

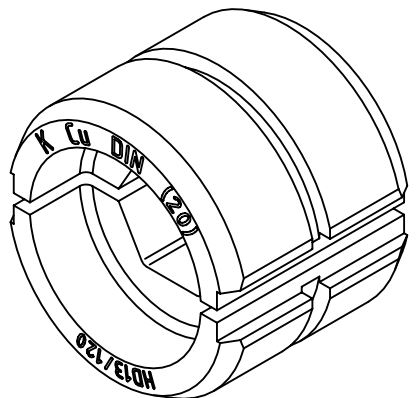
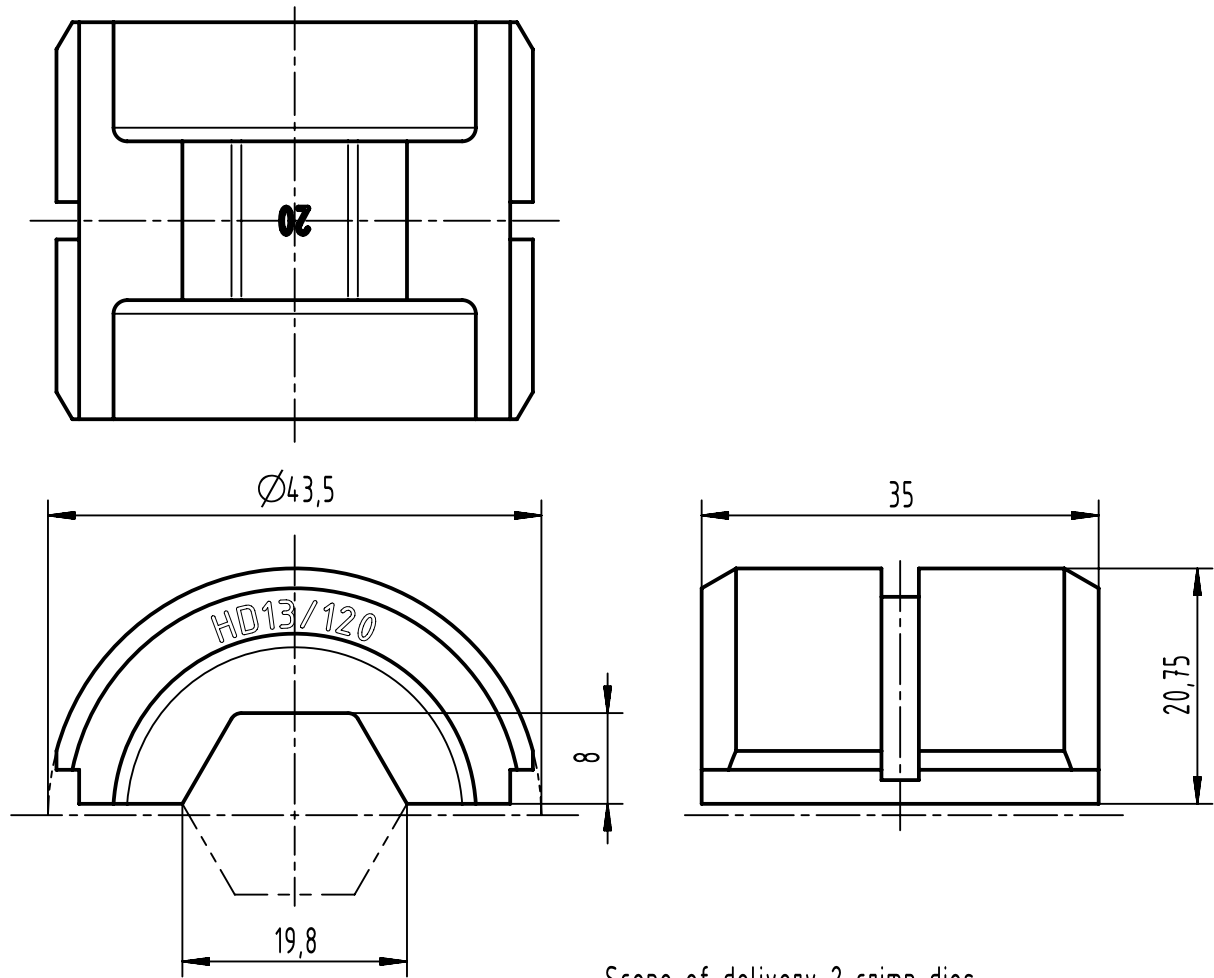

Scope of delivery 2 crimp dies

	All rights reserved Department EL PD	All Dimensions in mm Original Size DIN A4		Scale 1.5:1	Free size tol.	Ref. Sub.	
		Created by HOLLERT	Inspected by RIEPE	Standardisation RUETERA	Date 2021-01-08	State Final Release	
HARTING D-32339 Espelkamp		Title Crimp die 120mm ² for 120 kN tool				Doc-Key / ECM-Nr. 100587241/UGD/002/C 500000186965	
		Type TB	Number 09 99 000 0869			Rev. C	Page 1/1